



FLANGE A SALDARE DITESTA
WELDING NECK FLANGES

FLANGE CIECHE
BLIND FLANGES

CLASSE/CLASS
600
ASME B 16.47 **A**

J = da specificare dal cliente
J = to be specified by purchaser

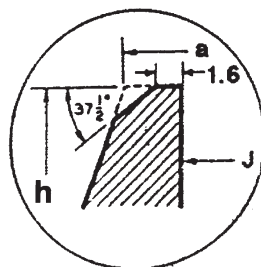

Dettaglio smusso
Bevel detail

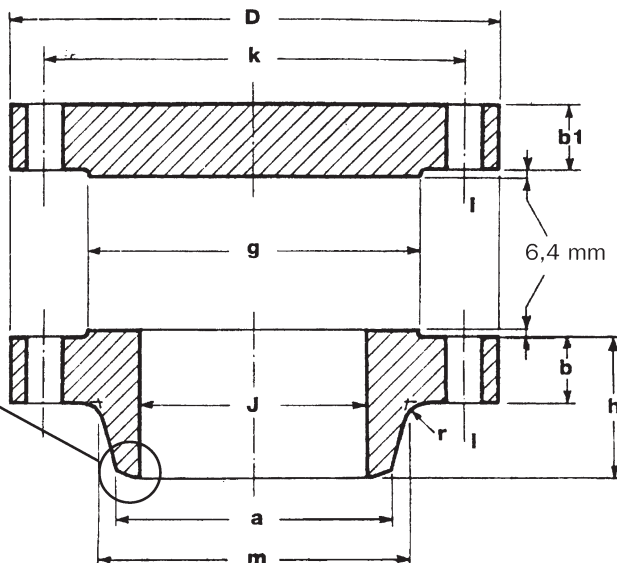

DIMENSIONS IN MM.

DN	D	b	b ¹	a	h	m	N. FORI HOLES	l	k	g	r	Kg	
												WN	BL
26	1016,0	108,0	125,4	660,4	222,0	748,0	28	51,0	914,4	749,3	11,1	444	768
28	1073,1	111,1	131,8	711,2	235,0	803,0	28	54,0	965,2	800,1	12,7	499	900
30	1130,5	114,3	139,7	762,0	247,5	862,0	28	54,0	1022,4	857,2	12,7	567	1065
32	1194,0	117,5	147,6	812,8	260,5	917,5	28	60,5	1079,5	914,4	12,7	633	1243
34	1244,5	120,7	154,0	863,6	269,5	973,0	28	60,5	1130,3	965,2	14,3	695	1417
36	1314,5	123,8	161,9	914,4	282,5	1032,0	28	66,5	1193,8	1022,4	14,3	789	1652
38	1270,5	152,4	155,6	965,2	254,0	1022,5	28	60,5	1162,1	1054,6	14,3	667	1499
40	1321,0	158,8	161,9	1016,0	263,5	1073,0	32	60,5	1212,9	1111,3	14,3	717	1683
42	1403,5	168,3	171,5	1066,8	279,5	1127,5	28	66,5	1282,7	1168,4	14,3	886	2015
44	1454,0	173,0	177,8	1117,6	289,0	1181,0	32	66,5	1333,5	1225,6	14,3	940	2233
46	1511,5	179,4	185,7	1168,4	300,0	1235,0	32	66,5	1390,7	1276,4	14,3	1044	2530
48	1594,0	188,9	195,3	1219,2	316,0	1289,0	32	73,0	1460,5	1333,5	14,3	1236	2939
50	1670,0	196,9	203,2	1270,0	328,5	1343,0	28	79,0	1524,0	1384,3	14,3	1442	3367
52	1721,0	203,2	209,6	1320,8	336,5	1394,0	32	79,0	1574,8	1435,1	14,3	1514	3667
54	1778,0	209,6	217,5	1371,6	349,5	1448,0	32	79,0	1632,0	1492,3	14,3	1659	4078
56	1854,0	217,5	225,4	1422,4	362,0	1501,5	32	86,0	1695,5	1543,1	15,9	1869	4571
58	1905,0	222,3	231,8	1473,2	370,0	1552,5	32	86,0	1746,3	1600,2	15,9	1981	4974
60	1994,0	233,4	242,9	1524,0	389,0	1610,0	28	92,0	1822,5	1657,4	17,5	2382	5737